

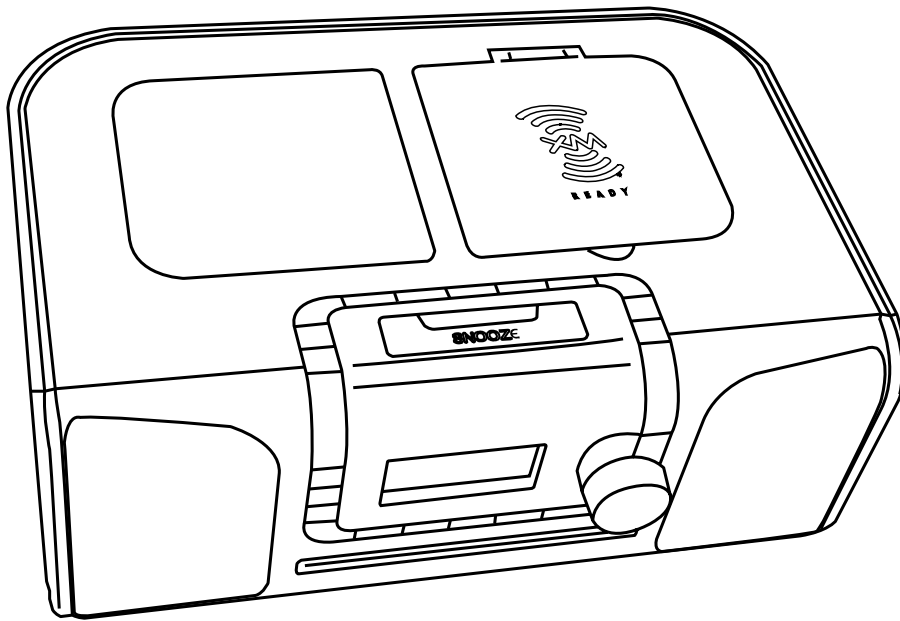

**AM/FM RADIO WITH XM RADIO,
iPod AND CD PLAYER CAPABILITY
Model XMC90**



Owner's Manual

1.0 Function of Controls and Indicators

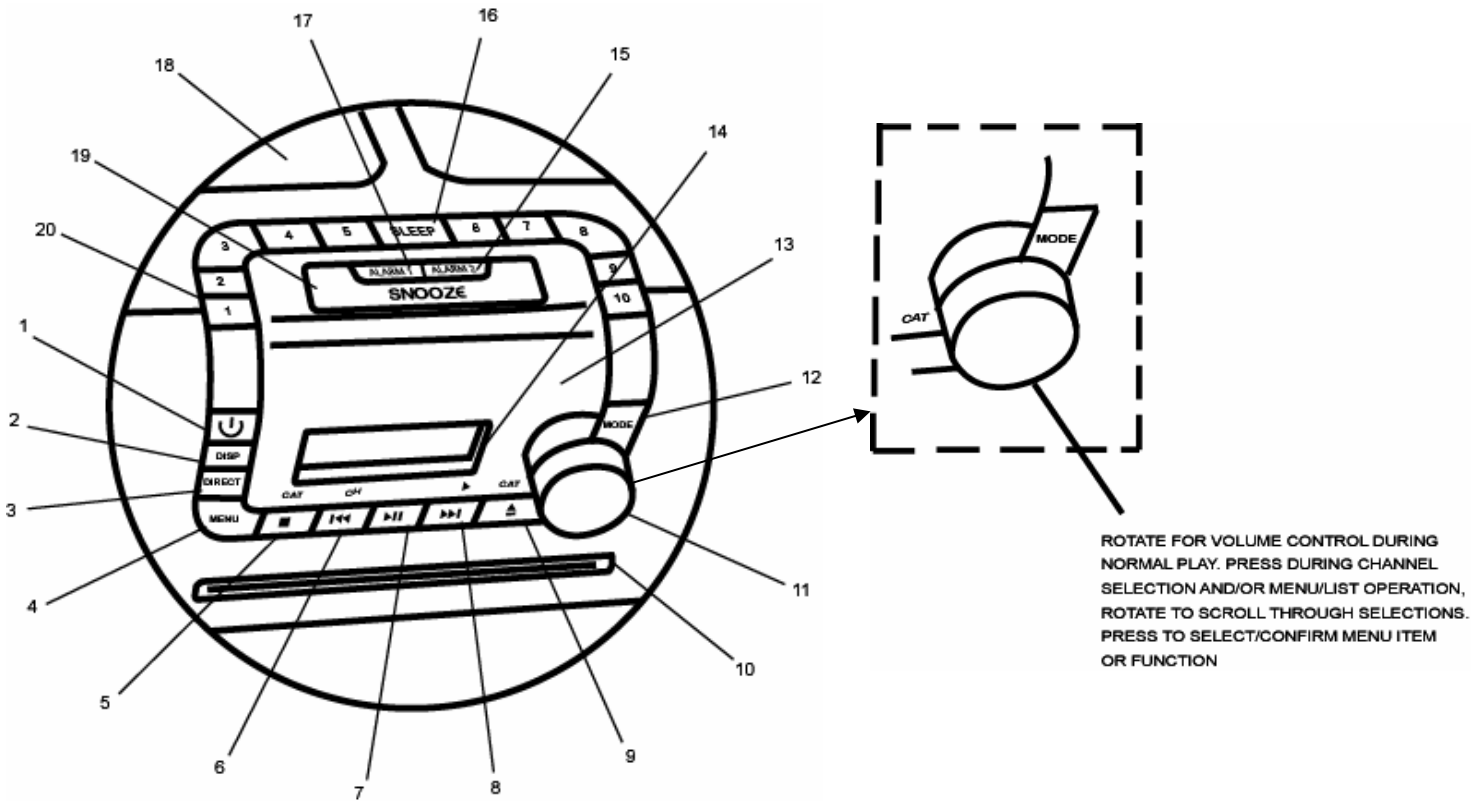

ROTATE FOR VOLUME CONTROL DURING NORMAL PLAY. PRESS DURING CHANNEL SELECTION AND/OR MENU/LIST OPERATION, ROTATE TO SCROLL THROUGH SELECTIONS. PRESS TO SELECT/CONFIRM MENU ITEM OR FUNCTION

- | | |
|--|--|
| 1. Power On/Off Button (Standby) | 11. Integral Scroll Wheel/Volume Control/Select Button |
| 2. DISP Button (Preset) | 12. MODE Button |
| 3. DIRECT Button (Direct/Preset A,B,C) | 13. Infrared (IR) Receiver Window |
| 4. MENU Button | 14. LCD Display |
| 5. XM: Category, AM/FM: Search, CD: Stop (■) | 15. ALARM 2 Button |
| 6. XM: Ch Down, AM/FM: Ch Down, CD: Previous Track | 16. SLEEP Button |
| 7. CD Play/Pause (▶) Button | 17. ALARM 1 Button |
| 8. XM: Ch Up, AM/FM: Ch Up, CD: Next Track | 18. Speaker, 4" Subwoofer |
| 9. XM: Category, AM/FM: Search, CD: Eject (▲) | 19. SNOOZE/Mute Button |
| 10. CD Player Slot (Label Up) | 20. Number Buttons (1-10) |

2.0 Unit Description

2.1 Power On/Off Button ()

When this button is pressed, power is applied to the radio circuits from the standby mode, and the unit enters into the play mode (XM/FM/AM/AUX/iPod). When pressed again during any play mode, power is removed from the radio circuits and the unit reverts to the standby mode. The default play mode is XM.

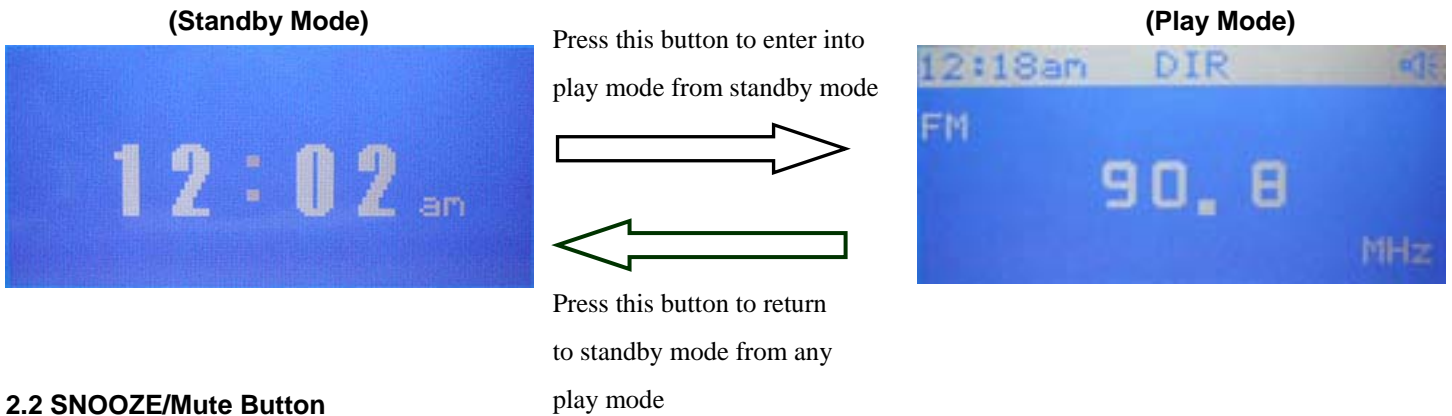

2.2 SNOOZE/Mute Button

When pressed during normal play mode (XM/FM/AM/AUX/iPod), the audio output is muted or disabled as indicated by the speaker icon in the upper right corner of the display screen. When pressed again, the mute function is canceled and audio is restored. While the alarm is active, press this button to enter the snooze mode.

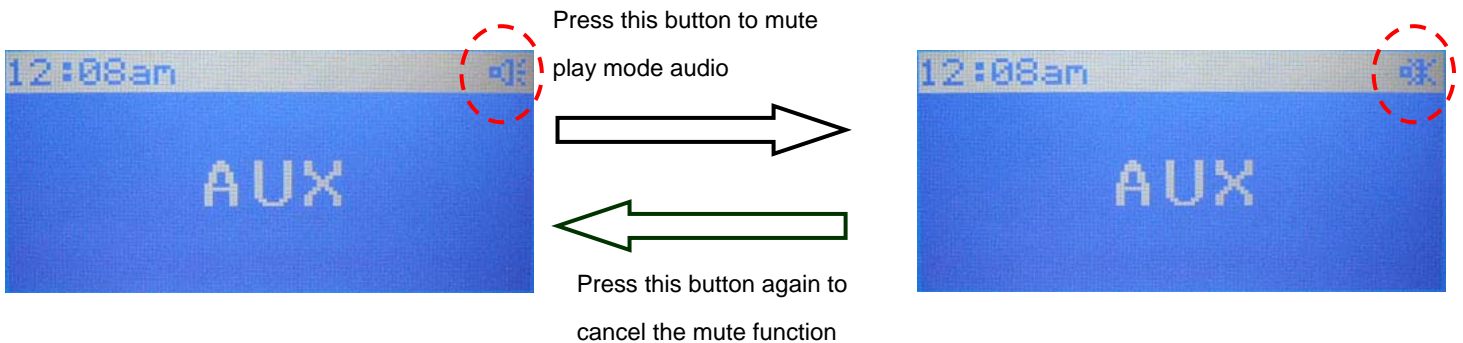

2.3 DIRECT Button (Preset)

During normal operation, direct selection of the radio frequency in the XM, FM or AM radio modes is possible. To change FM or AM frequency, use the CH Up/Down buttons or directly enter desired frequency using the number (1-10) buttons. To search radio frequencies in FM/AM modes, press the CAT Up/Down buttons. In XM mode, the CAT Up/Down buttons provide a jump to the various broadcast categories or genres. When the DIRECT button is pressed, Direct (DIR) disappears on the display, and is replaced with preset bank A, B or C. Each bank is capable of storing up to 10 radio frequencies in memory. The frequency is stored by pressing the corresponding number buttons (1-10) for 3 seconds, thus permitting memory storage of 30 frequencies. When this button is pressed and held, the list of stored frequencies in the current band can be viewed. Press the CH Up or Down buttons to scroll through the preset channel list.

2.3.1 FM/AM Radio Ranges

In DIRECT mode, the FM radio band ranges from 88.1 to 107.9MHz, while the AM band ranges from 530 to 1710kHz.

2.3.2 Changing FM/AM Radio Frequencies

FM and AM radio frequencies can be changed by using the CH Up/Down buttons; each button press changes the frequency in 100kHz steps (FM). Pressing the CAT Up or Down button enters the frequency search mode.



Press the CH +/- buttons to change FM frequency in 100kHz steps; press select

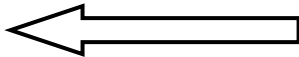
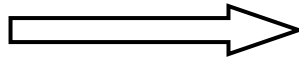

OR

Press the number buttons to directly enter frequency; press select to confirm



Press the CAT +/- buttons to auto search for desired FM or AM frequency

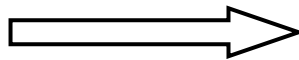

Press DIRECT button to preset A, B, C, and hold number button (1-10) over 3 seconds to store station frequency in memory bank A

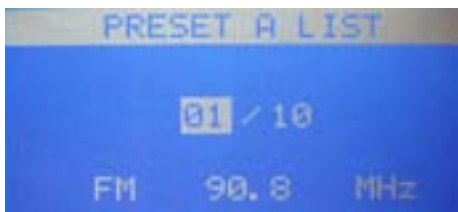

Press and hold DIRECT button over 3 seconds to display list of stored frequencies in current bank. Press the CH Up or 7 preset Down buttons to scroll through selections

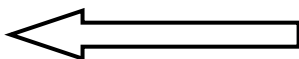

2.4 MENU Button

When MENU is pressed, a list of menu items appears on the display. Select the desired item using the Channel Up (◀CH) and Channel Down (CH ▶) buttons to highlight the item; then press the SELECT button to enable adjustment of the selected parameter.

- Menu Item:**
- 1-SOFTWARE VERSION
 - 2-FACTORY DEFAULT
 - 3-LCD SETTING
 - 4-AUDIO SETTING
 - 5-XM SETTING
 - 6-CLOCK SETTING

2.4.1 SOFTWARE VERSION: When selected, this item displays the software version and XM version installed in this unit.

During any play mode, press the menu button; then press CH+/- to highlight this item



Then press select

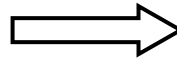
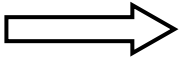

2.4.2 FACTORY DEFAULT: When selected, this item returns all user presets to factory default parameters.

During any play mode, press the menu button; then press CH+/- to highlight this item



Press CH+/- to highlight this item; then press select

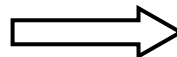
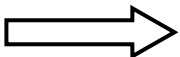

Note: All custom settings will be lost, including presets.

2.4.3 LCD DISPLAY SETTING:

2.4.3.1: Contrast Setting: When selected, this item enables adjustment of the display contrast within the range 0~10. The factory default setting is 3.

During any play mode, press the menu button; then press CH+/- to highlight this item and press select

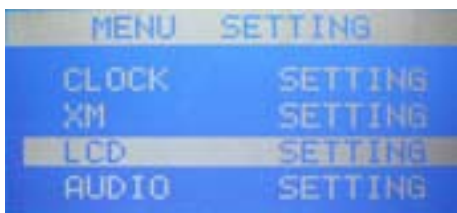

Press CH+/- to highlight this item; then press select. Adjust contrast range using CH+/-

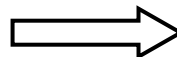
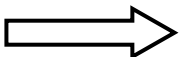

2.4.3.2 Display Setting: Enter this item to switch the LCD screen image from positive to negative.

2.4.4 AUDIO SETTING: When selected, this item enables adjustment of the BASS and TREBLE parameters, each within a range of -5 to +5, and also enables activation of SURROUND sound (ON/OFF).

During any play mode, press the menu button; then press CH+/- to highlight this item



Then press select. Adjust BASS/TREBLE range using CH+/- and select

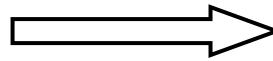
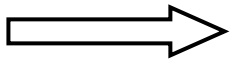

2.4.5 XM SETTING: When selected, this item provides the capability of setting up XM options for display of information such as sports teams, current scores or stock information. Press MENU to access the menu options display; scroll up/down to XM SETTING using the CH +/- buttons and press Select.

During any play mode, press the menu button; then press CH+/- to highlight this item



Press select button for Info Extra

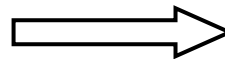
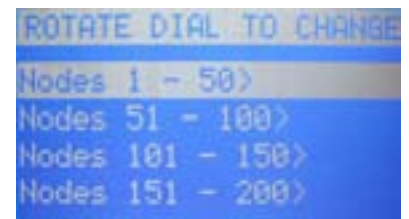

Press select button for Stock Ticker to add or erase a stock symbol

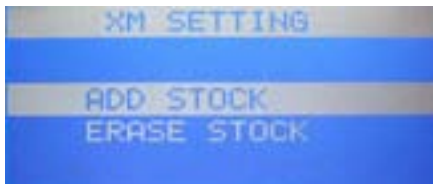

To add a stock symbol, press Ch+/- until the 1st letter of the symbol is seen. Press Select to move to next letter. Once all letters are entered, press Select to confirm.

2.4.6 CLOCK SETTING: When selected, this item sets the current time in either the 12 or 24 hour system.

During any play mode, press the menu button; then press CH+/- to highlight this item

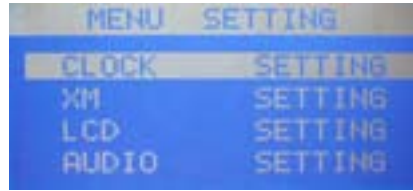

Then press select

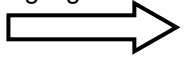
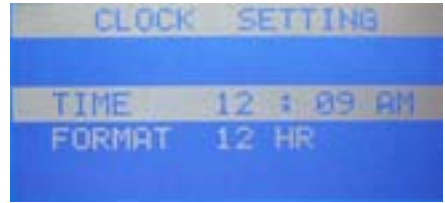

Select "STOCK TICKER", then select 'ADD Stock'. Use the ch+/- to select the first letter in the stock symbol. Press Select to confirm. Repeat to select other letters in the stock symbol. Press Select to confirm..

2.5 ◀ CAT/CAT ▶ Buttons

In AM and FM modes, these buttons enable up/down radio station auto-search. In XM Mode CAT buttons skip station genre by category.

2.6 ◀ CH/CH ▶ Buttons

These buttons enable channel selection up or down in the XM, FM and AM radio modes. In FM and AM mode, each press of the channel button(s) provides a frequency step of 110kHz radio station frequency, 100/110kHz when in station preset, provides up or down channel selection.



In FM mode, press CH+/- to change channel frequency in 100kHz steps.

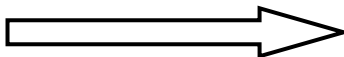

In AM mode, press CH+/- to change channel frequency in 10kHz steps.

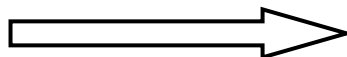

2.7 Integral Scroll Wheel, Volume Control and Select Button

This integral scroll wheel/volume control and select button provides selection of various menu and submenu items by rotating the scroll wheel in the XM/FM/AM/AUX/iPod modes. then press in the scroll wheel (Select button) to make or confirm the selection. During auto-search in the FM and AM modes, pressing this button cancels the search function.

2.8 Volume Control and Select Button

2.8.1 Volume Control

This integral scroll wheel/volume control and select button is also used to adjust the speaker volume (when not scrolling through menu items for selection or adjustment) in the XM/FM/AM/AUX/iPod modes within the range of 0~30.



Rotate the scroll wheel to adjust the output volume in any mode

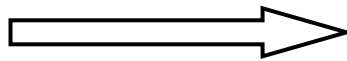

2.8.2 Select Button

Momentarily press and release the scroll wheel to activate the scrolling function. In XM/iPod mode, press the scroll wheel twice; a beep will be heard. Then rotate the scroll wheel to browse the XM/iPod menu.

2.9 MODE Button

This button enables selection of one of five play modes in a sequential wrap-around format (XM/FM/AM/AUX/iPod).

Press this button in any play mode; the current mode is highlighted

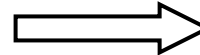
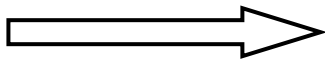

Use the scroll wheel to highlight another selection; press the select button to select the new

2.10 Infrared (IR) Receiver Window

This window detects the IR signal from the remote control to select operating modes and feature functions.

2.11 LCD Display

Displays operating modes, menus and other related information on the LCD screen.

2.12 SLEEP Button

Press this button to set a sleep time of 30, 60 or 90 minutes; use the scroll wheel to scroll through and highlight the available sleep times, then press select. The radio will turn off automatically when the sleep time has expired.

Press the sleep button in any play mode

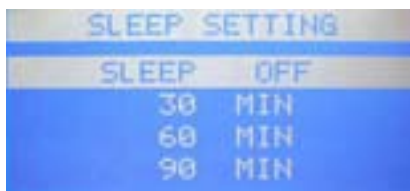

Highlight the desired sleep time, then press select

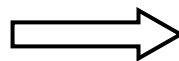

2.13 Number Buttons 1-10

These buttons are used to directly input radio station frequency/channel number in XM, FM and AM modes. They are also used to store a desired frequency in preset memory bank A, B, or C when the station preset function is active.

2.15 ALARM1/ALARM2 Buttons

These buttons set the Alarm 1 or Alarm 2 functions.

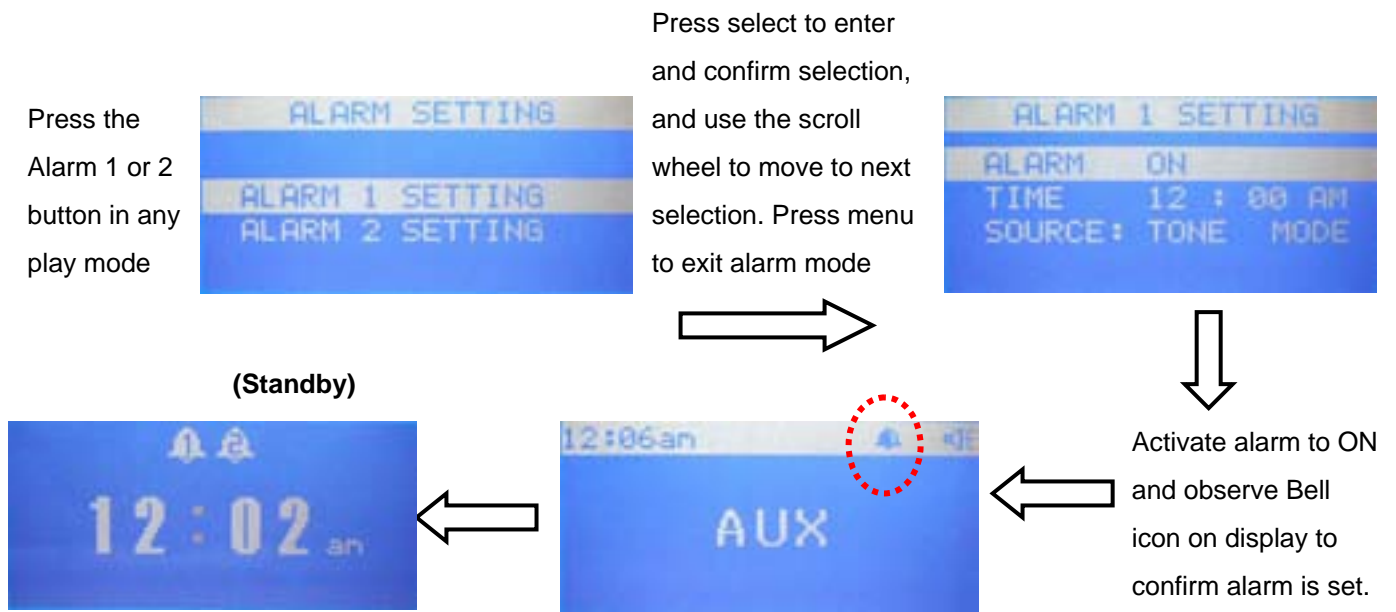

2.16 SNOOZE (MUTE) Button

Adjust the Snooze time once in Alarm 1 or Alarm 2 mode. This button sets the Snooze time between 1 and 20 minutes when the alarm sounds. Rotate the scroll wheel to advance Snooze time in 1-minute increments.

Press the snooze/mute button during alarm setting to access snooze adjustment mode



3.0 iPod Docking Station

This station provides docking accommodations for an external iPod. When properly installed, iPod operation can be controlled using the XMC90 controls.

3.1 Using the iPod Dock

1. Swing up the protective cover door to access the iPod/XM receiver system connector bay.
2. Choose the compatible adapter/holder for your iPod model and install it in the bay.

Note: The XMC90 is supplied with an iPod adapter for installation in the iPod bay. Most iPods come with their own (original) adapters which can also be used if necessary.

3. Install the iPod carefully onto the iPod connector and press down lightly until the iPod bottoms into the recess. The iPod will be inclined slightly toward the rear of the XMC90.
4. Press the MODE button to highlight the current mode and rotate the scroll wheel until iPod is highlighted; then press select and observe the following display screens:

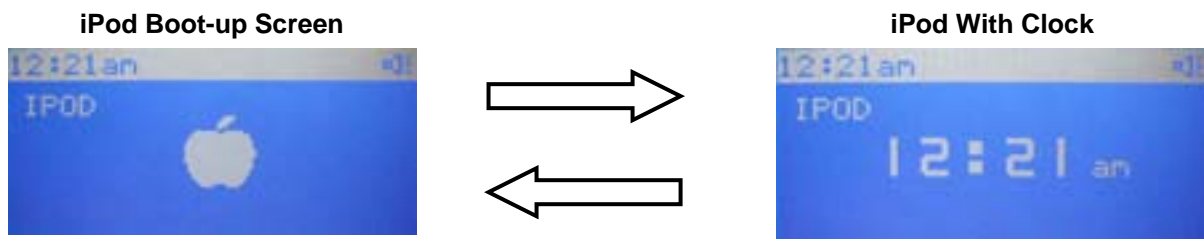

5. Press Scroll Wheel twice; a beep sounds and the iPod menu can now be accessed using the Scroll Wheel.

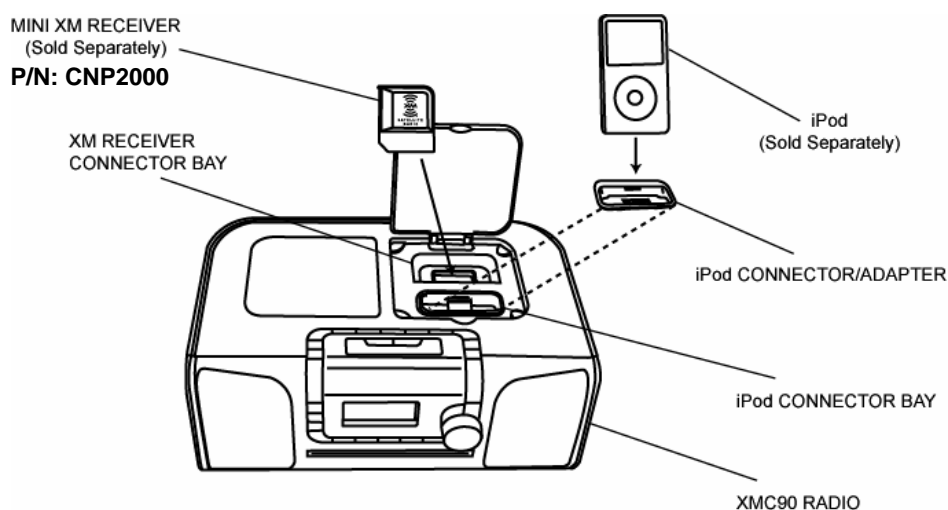

4.0 XM Docking Station

This station provides docking accommodations for an external mini XM receiver. (Refer to previous figure.)

Note: The XM mini receiver and XM antenna are not included with the XMC90.(P/N:CNP2000)

4.1 Using the XM Docking Station

1. Swing up the protective cover door to access the iPod/XM receiver system connector bay.
2. Install the mini receiver carefully onto the receiver connector and press down lightly until the receiver bottoms into the recess.

Note: The receiver can be inserted in one way only; the XM logo should face toward the front of the unit.

3. Press the MODE button until XM is highlighted; then press the Scroll Wheel select button.



If a receiver fault occurs or if the receiver is improperly installed, the following message screen appears:

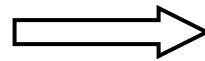

If the XM antenna is not connected, or an XM antenna fault occurs, the following message screens may appear:

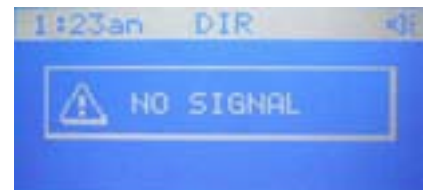
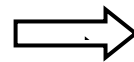
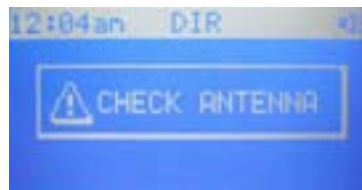
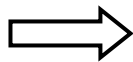

Use the number (1-10) buttons to directly select a channel number, or press the select button twice; a beep occurs and the scroll wheel can be used to browse the channel list

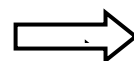

Note: After 20 seconds, channel scroll will time out and the scroll wheel will return to Volume Control.

Select the Category using the CAT+/- buttons; select channel within the category using the CH+/- buttons or scroll wheel

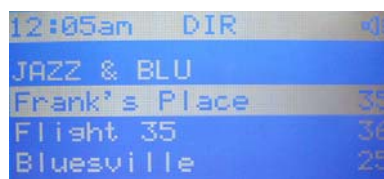
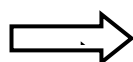

Set Preset

First set the desired channel number.

Press DIRECT to access the desired memory bank ; press and hold the desired 1-10 number using the number buttons

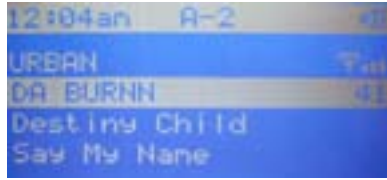

Press and hold DIRECT to access preset channel list in memory bank A; press CH Up or Down to scroll through selection.

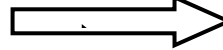

5.0 CD Functions

When playing discs, use the Mode control to select the CD functions.

Press play/pause button to initiate CD play mode

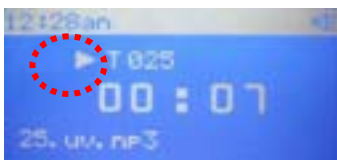

During play, press play/pause button to pause CD play

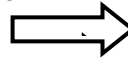
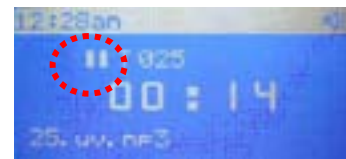

During play, press stop button to halt CD

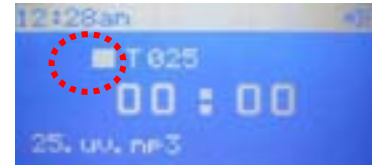

During play, momentarily press fast forward (⏩) button to advance to next track; press and hold for rapid scan

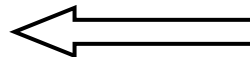
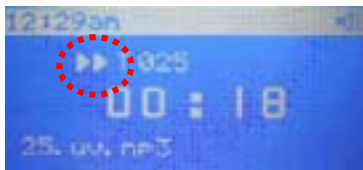

During play, momentarily press fast reverse (⏪) button to return to previous track; press and hold for rapid reverse



During play, press shuffle (remote only) button to play songs in a completely random manner

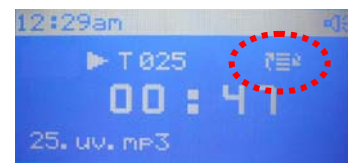

During play, press repeat (remote only) button once to re-play current song



During repeat play, press repeat (remote only) button again to re-play all songs on the disc once

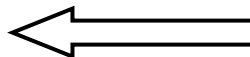
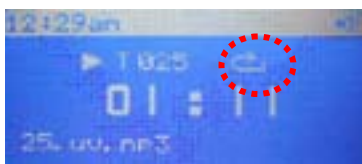

6.0 Other CD Functions

When playing audio CDs, if the CD function is selected with the MODE button button, and no CD is loaded, the following message appears on the display:

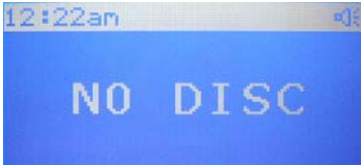

If a CD is loaded, and the CD mode is selected, the initial display conveys the number of folders on the disc and the total number of tracks.



7.0 Connector Functions

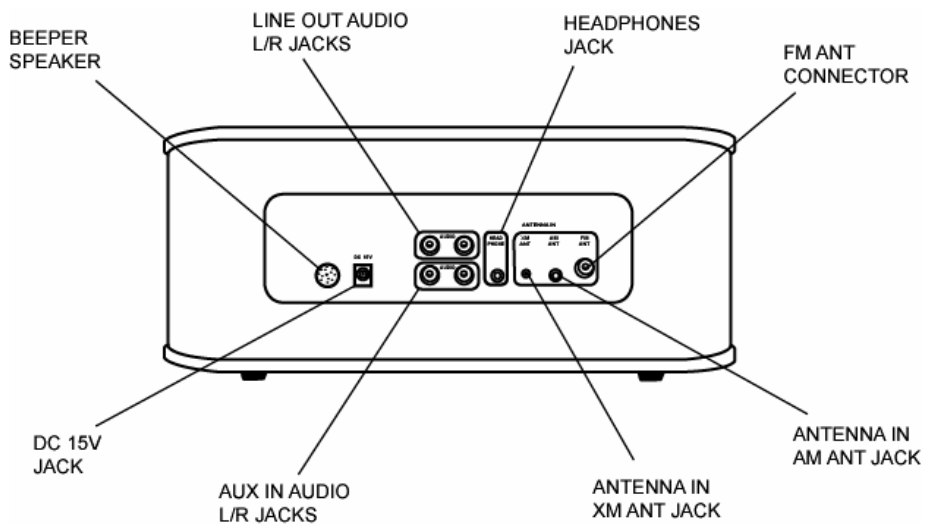

7.1 Beeper Speaker

This speaker provides beeper tone alarm audio output.

7.2 DC IN Jack

This jack connects to the 15 V DC output of the AC/DC adapter supplied with the radio.

7.3 AUX IN Jack

This RCA (red/white) stereo type jack accepts an external audio input from an optional DVD player, video game console, etc.

7.4 Headphone Jack

This 3.5mm jack provides an audio output to external stereo headphones.

7.5 XM Antenna Connector

This jack provides input connection for the external SMB type XM antenna which is sold separately.

7.6 AM Antenna Connector

This jack provides input 3.5mm connection for a stereo headphone type AM loop antenna supplied with the unit.

7.7 FM Antenna Jack

This connector provides input for a 75Ω F-connector type FM antenna supplied with the unit.

7.8 Port Tube



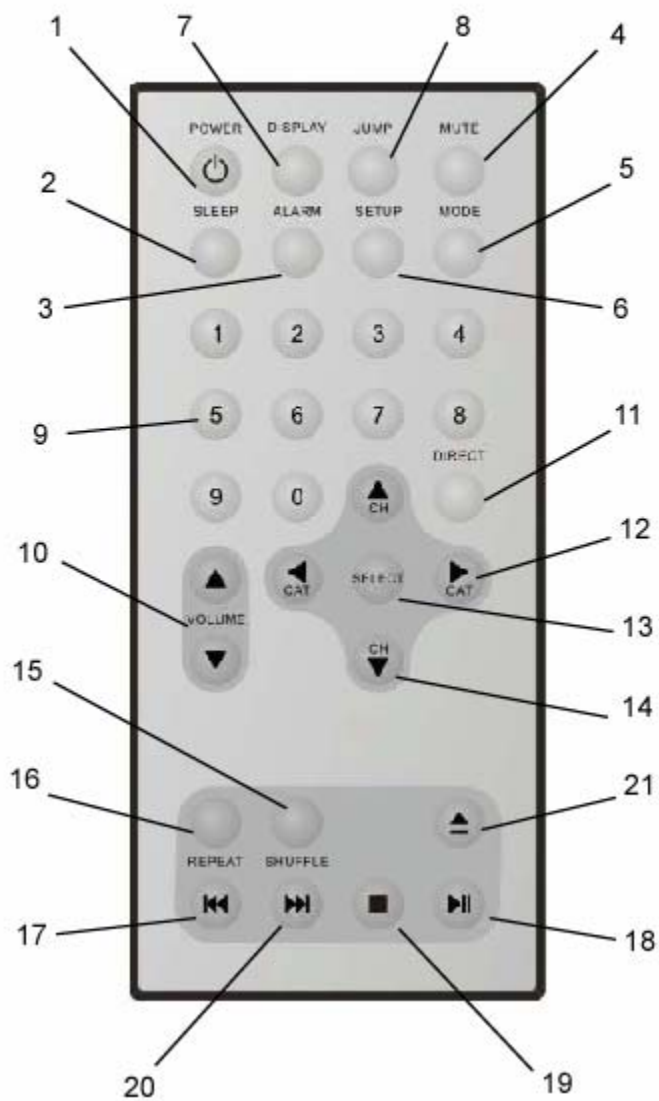

This port on the bottom of the unit provides a heat exhaust for the speaker. DO NOT BLOCK THIS PORT.

8.0 Remote Control

The remote control provides remote commands for both the radio and for an iPod.



1. **POWER Button:** Places unit in standby or power on condition.
2. **SLEEP Button:** Enters sleep setting.
3. **ALARM Button:** Sets alarm time.
4. **MUTE Button:** Sets audio mute on-off.
5. **MODE Button:** Switches between play modes (XM/FM/AM/AUX/iPod).
6. **SETUP Button:** Same function as MENU on radio; displays menu items for parameter setup.
7. **DISPLAY Button:** In XM mode, sequential presses of this button initiate a display of the **STOCK** ticker info with scrolling artist/song title, the **SPORTS** ticker (latest sports info) with scrolling artist/song title, and stationary **ARTIST/SONG** title info currently playing.
8. **JUMP Button:** In XM mode, pressing the **JUMP** button initiates an immediate return to the previous category, or genre, without having to press the **SELECT** button
9. **Number (1-10) Buttons:** Same function as radio; used to directly input station frequency, and for selecting station number for memory storage.
10. **VOLUME ▲/▼ Buttons:** Same function as radio; used to control speaker volume.
11. **DIRECT Button:** Same function as radio; used to directly enter station frequency and to store frequencies in memory banks A, B or C for later recall by the user.
12. **CAT◀/▶ Buttons:** Same function as radio; used for station auto-search in AM and FM modes; provide category search in XM mode.
13. **SELECT Button:** Same function as radio; provides selection of highlighted screen items and also confirms input selections. In AM and FM modes, during station frequency auto-search, if search doesn't stop automatically, pressing **SELECT** halts the auto-search function.

14. **CH▲/▼ Buttons:** Used to select radio station frequency in radio mode, and also highlights menu mode items for adjustment. Also used to control selection of iPod menu items.
15. **SHUFFLE Button:** Press this button to play iPod songs in a completely random manner.
16. **REPEAT Button:** When pressed once, current iPod song is repeated; when pressed a second time, current song is played continuously.
17. **Fast Reverse () Button:** Press and hold this button to fast reverse through current playing song; press and release to go to previous track.
18. **Play/Pause () Button:** This button controls the play and pause functions of the iPod. When pressed during play mode, song play is paused; when pressed again, song play is resumed.
19. **Stop () Button:** Press this button to stop current song play.
20. **Fast Forward () Button:** Press and hold this button to fast forward through the current playing song; press and release to go to the next track.
21. **CD Eject () Button:** Press this button to eject the disc from the CD player.

9.0 Initial Use* and Battery Replacement

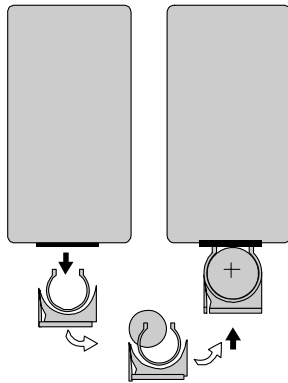

*When purchased the remote control has a battery installed with a plastic insert to prevent battery discharge. Remove the plastic insert before attempting to use the remote.

1. Remove the battery holder. Refer to the drawing.
2. Insert the battery into the battery holder and insert the battery holder into the remote. Be sure to observe the correct polarity
3. For best results, aim the remote directly at the remote receiver window within 10 feet, and angles not exceeding 60 degrees.
4. The path between the remote control and remote sensor should be free of obstructions.
5. Under normal use the battery will last for approximately one year.
6. Remove the battery if the remote is not going to be used for a long time or during storage.

NOTES

© 2008 Audiovox Electronics Corporation, 150 Marcus Blvd., Hauppauge, NY 11788

128-8283